



NORDIC SPOT

spot the difference



WE TURN ON THE LIGHT

..complete lighting solutions at their best



WHO IS NORDIC SPOT?

We are not just another lighting company.. We are game-changers in the industry!

With our passion for light and 20 years of solid experience within our team, we have created Nordic Spot to revolutionize your experience of display and showcase lighting.

Whether it is “one-size-fits-all”, custom-made lighting or something in between, we are ready to spot the perfect solution.

Welcome to Nordic Spot and our lighting universe, where our know-how, passion and creativity sets a new standard for display and showcase lighting in the industry!

OUR CORE

QUALITY

Our products not only meet the standard - they set it.

By selecting the best suppliers and imposing high demands on their products, we ensure that the lighting has high performance and durability.

Through our many years of experience with display lighting, we can spot quality in both materials and the lighting itself.

And we do not compromise on any of it.

TECH

We stay updated on the latest trends and new technology.

We challenge our suppliers to be quick as lightning and in constantly development, so we can deliver products that has the latest technology within them.

As spotlight specialists, we are experts in technology. We know what is inside our products and how everything works.

Therefore, we are confident in offering a 5-year warranty on our products.

DESIGN

Let's face it - Looks do matter. So we combine function and aesthetics.

With a competent and dedicated design unit, we can ensure designs for any needs. We can also create prototypes, so our customers can "see with their fingers."

We combine both quality and technology with that touch of beauty, you wish for in your showcase or display.

This ensure that we deliver products, that bring out the best in yours.

CHECK OUT OUR PORTFOLIO

..a spotlight on selected products

ON MINI SPOT

..small spot, big personality



Here's your go-to miniature spotlight - Designed to highlight your products from any angle, with elegance and flexibility combined.

With adjustable and rotatable light direction, it's bye, bye to poorly lit products and hello to perfect lighting.

On Mini Spot has a magnetic backside and can easily be mounted on magnetic power tracks. This creates flexibility, quick installation, and easy maintenance.

On Mini Spot offers functionality, flexibility, and aesthetics – What's not to like?

SPECS, TECHS & LOOKS

Beam Angle:	20° 30° 40°
CCT:	3000 K 4000 K 5000 K
Color:	Black White Silver Brass Rose gold
System Power:	1W 2W 3W
System Flux:	1W = 70lm 2W = 130lm 3W = 175lm
Color rendering:	CRI > 90
Material:	Aluminium
Efficacy:	70Lm/W
Input	24V CV
Lifetime:	50.000 hours
Protection:	IP20
Dimensions:	1W = Ø 22x43 mm 2W = Ø 22x49 mm
Certifications:	CE, UL

 nordicspot

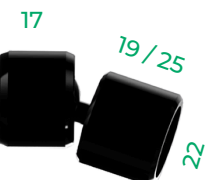

1W Spot:	2W Spot:
22 mm	22 mm
19 mm	25 mm
17mm	17mm

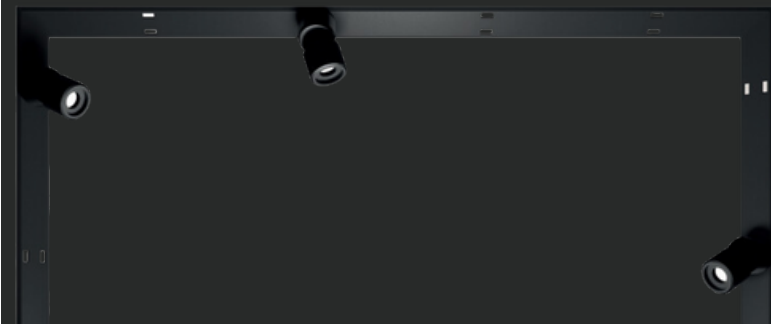

ON STICK STRAIGHT

..your showcase, your rules

This is not just a pretty thing, but also a flexible one.

With a simple push or pull, On Stick Straight can be adjusted in height by +/- 50 mm. This allows for customization to perfectly suit you and your products.

With a 90-degree direct light distribution, it ensures even and efficient lighting. Moreover, it is available in two heights, leaving no excuse for why On Stick Straight wouldn't fit your display and showcase.



SPECS, TECHS & LOOKS

Beam Angle:	90°
CCT:	3000 K 4000 K 5000 K 6500 K
Color:	Black White Silver Brass Rose gold
System Power:	3W 4W
System Flux:	300lm/3 chips 400lm/4 chips
Color rendering:	CRI > 90
Material:	Aluminium
Efficacy:	110Lm/W
Input	350mA CC
Lifetime:	50.000 hours
Protection:	IP20
Dimensions:	Ø8 x 250 / 150 mm Both can be adjusted + / - 50mm
Certifications:	CE, UL

250 mm

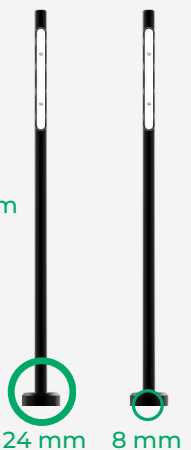

24 mm 8 mm

DISPLAY AND SHOWCASE LIGHTING AT ITS BEST

ON STICK BEND

..the right angle

With its elegant angle and love for low voltage, On Stick Bend is the perfect match for displays and showcases.

It is designed to illuminate jewelry, watches, porcelain, glass and accessories, where lighting should not only be practical, but a part of the show.

On Stick Bend is ready to put products in the spotlight and give them the attention they deserve.

SPECS, TECHS & LOOKS

Beam Angle:	120°
CCT:	3000 K 4000 K 5000 K 6500 K
Color:	Black White Silver Brass Rose gold
System Power:	3W
System Flux:	300lm
Color rendering:	CRI > 90
Material:	Aluminium
Efficacy:	110Lm/W
Input	350mA CC
Lifetime:	50.000 hours
Protection:	IP20
Dimensions:	Ø8 mm / height: 315 mm
Certifications:	CE, UL

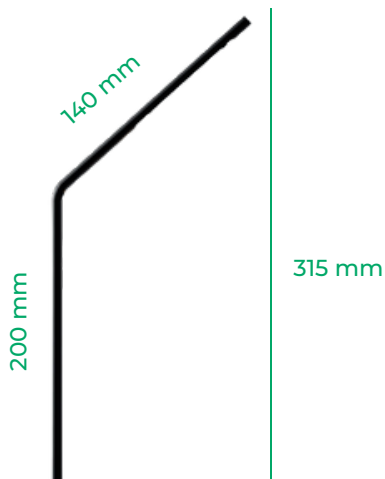

ON MINI SPOT CARDAN

„I like to move it, move it“

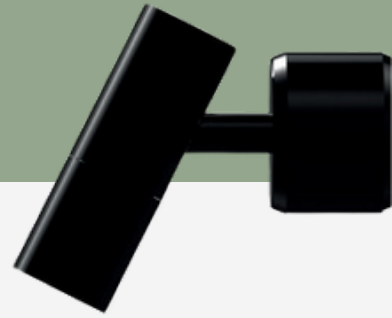
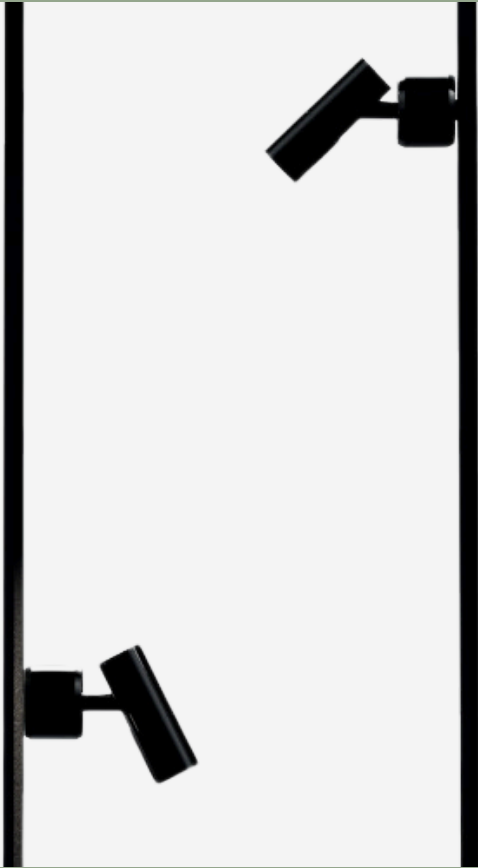

With On Mini Spot Cardan, precise displaylighting is once again the main focus - With a thick line under “precise”.

The tiltable head gives On Mini Spot Cardan greater mobility, allowing it to target lighting on a whole new level.

On Mini Spot Cardan can easily be mounted on magnetic power tracks.

Flexibility and easy maintenance are thus words we absolutely can vouch for.

 nordicspot

SPECS, TECHS & LOOKS

Beam Angle:	20° 30° 40°
CCT:	3000 K 4000 K 5000 K
Color:	Black White Silver Brass Rose gold
System Power:	1W 2W 3W
System Flux:	1W = 70lm 2W = 130lm 3W = 175lm
Color rendering:	CRI > 90
Material:	Aluminium
Efficacy:	70Lm/W
Input	24V CV
Lifetime:	50.000 hours
Protection:	IP20
Dimensions:	Ø 22 x 60 mm
Certifications:	CE, UL

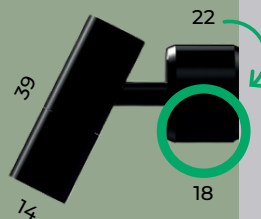

ON POLE

..Three is NOT a crowd



On Pole is the ultimate display lighting, equipped with 3 powerful LED chips that target the core areas of the products.

With its innovative design, available in 3 different heights and with a tiltable head, On Pole sets a new standard for flexibility.

On Pole discreetly blends in with its minimalist design, letting the products take center stage.

SPECS, TECHS & LOOKS

Beam Angle:	20°
CCT:	3000 K 4000 K 5000 K 3500 K
Color:	Black White Silver Brass Rose gold
System Power:	1W 2W 3W
System Flux:	210lm
Color rendering:	CRI > 90
Material:	Aluminium
Efficacy:	70Lm/W
Input	350mA CC
Lifetime:	50.000 hours
Protection:	IP20
Dimensions:	Head Ø 16,5 x 86 mm Height 70 / 145 / 260 mm Other heights on request
Certifications:	CE, UL

 nordicspot

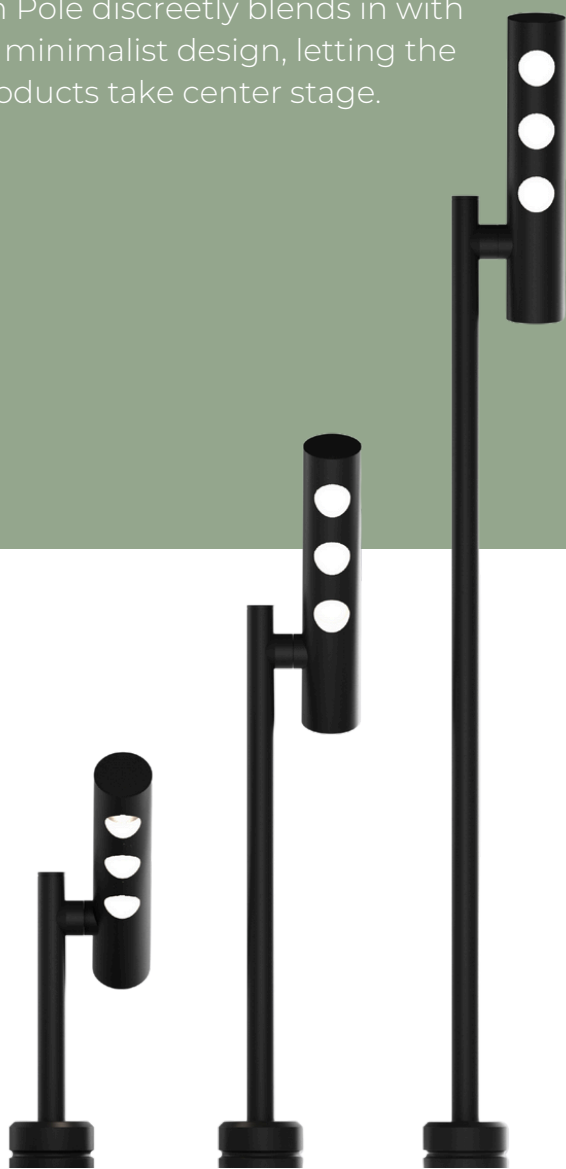
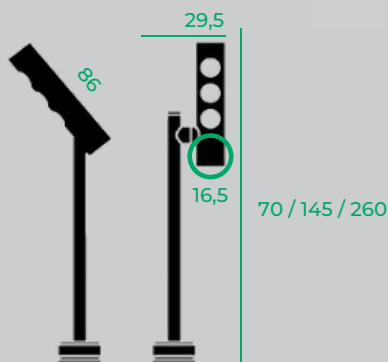

THE VIKINGS ARE COMING

.. dont worry, they come in peace

ODIN QUANTUM

..only have eyes for you



Odin Quantum is ultra slim and elegant.

With a seriously flexible and tiltable head, the products are guaranteed full focus.

With its "plug n' play" system, Odin Quantum offers easy installation, that can save you from many "ohh noo" moments.

Psst.. It´s also dimmeable.

SPECS, TECHS & LOOKS

Beam Angle:	10 - 40 °
CCT:	3000 K 4000 K
Color:	Black
System Power:	2.1W / 3V
System Flux:	100lm
Color rendering:	CRI > 93
Material:	Aluminium oxidized
Efficacy:	48Lm/W
Input	700mA
Lifetime:	50.000 hours
Protection:	IP20
Dimensions:	535 x 335 x 385 mm

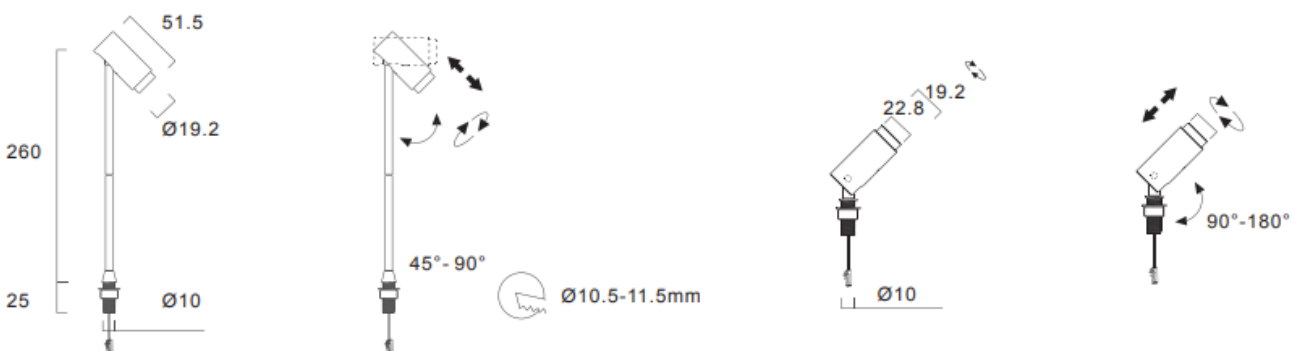

HUGIN AURORA

..as beautiful as the northern light



SPECS, TECHS & LOOKS

Beam Angle:	18 - 40 °
CCT:	3000 K 4000 K
Color:	Black
System Power:	1.5W
System Flux:	110lm (3000 K) 120lm (4000 K)
Color rendering:	CRI > 93
Material:	Aluminium oxidized
Efficacy:	73Lm/W (3000 K) 80Lm/W (4000 K)
Input	500mA
Lifetime:	50.000 hours
Protection:	IP20
Dimensions:	305 x 360 x 265 mm

A beautiful recessed spotlight,
filled with quality and flexibility

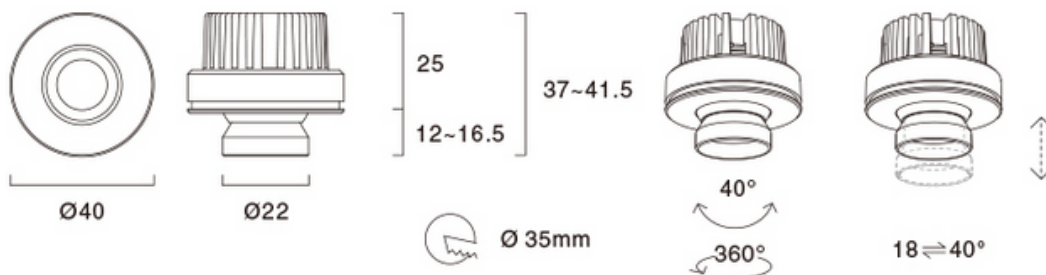

WHEN WE SAY “COMPLETE SOLUTIONS”, WE´RE NOT JOKING

We can provide everything (and we mean EVERYTHING)
for your showcases and displays

At Nordic Spot, you will find a variety of lighting
products for displays and showcases.

Please reach out, if there´s products you are
missing. If we don´t have them, we´ll find
them.

- SPOTS
- SIGNS
- ALUMINUM PROFILES
- DOWNLIGHTS
- LIGHTSHEETS
- FOIL

What they all have in common, is that all the
products have to meet our core values:

Quality, Design & Technology

YOU WANT IT? YOU GOT IT!

..custom-made solutions at its best

We are spotlight specialists who combine expertise and know-how with a very special eye for details.

We help create unique solutions that provide the best first impression and are an extension of your brand.

“You want it? You got it!”, are not just words. It's a mission.

Your showcase
Your rules

LET'S KEEP IN TOUCH

If you have any questions about products, solutions or anything else, please reach out. We look forward to hearing from you.

Anders Nørrestrand
+45 22 32 15 25
an@nordicspot.net
info@nordicspot.net



We'd love to connect



www.nordicspot.net

spot the difference